

WHEELCHAIR MAINTENANCE AND MINOR REPAIRS

Tools for basic repairs:

- Hex (Allen) wrenches 5/32 and 3/16 and 4mm and 5mm most common, but a set will cover all needs
- Socket wrench ¼" drive or 3/8" drive with 3/8", 7/16", ½", 9/16" sockets or metric as appropriate for your wheelchair
- Adjustable wrench 10" and 12"
- Phillips head screwdriver
- 2 tire levers for pneumatic tires
- Tire pump
- Owner's Manual

Emergency Tool kit:

Items to carry with you at all times:

1. Spare inner tube (as appropriate)
2. Hex (Allen) wrenches 5/32" and 3/16" or 4mm and 5mm (as appropriate)
3. Small adjustable wrench
4. Hand pump or air cartridge

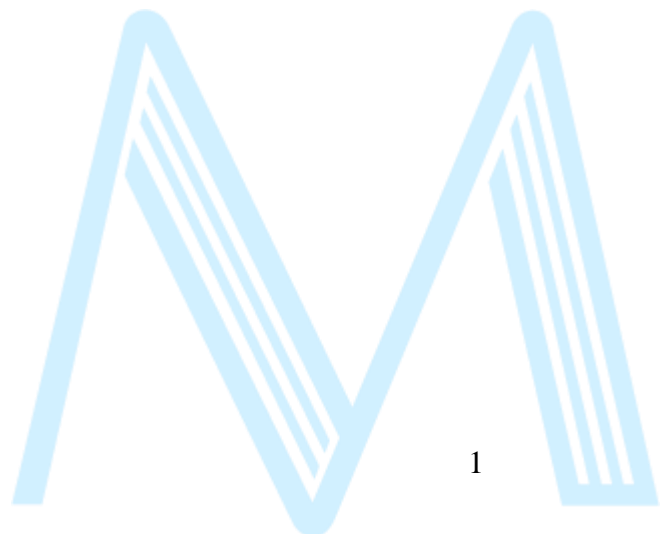

Manual Wheelchair Maintenance:

Weekly:

- Wipe down your chair
- Check tire pressure
- Check the wheel locks
- Check for loose spokes (if applicable)
- Check wheelchair cushion for bottoming out

Monthly:

- Clean your cushion and cover
- Clean and wax your frame
- Check for loose nuts and bolts
- Clean and inspect casters
- Backrests
 - Solid backrest: check that brackets are properly positioned and secure
 - Adjustable sling back: check tension
- Check footrest or footplate for proper positioning
- Check the bolt which attaches the handrim to the wheel
- Check the lumbar supports and other inserts for proper positioning
- Check wheel alignment
- Inspect chair frame for cracks
- Clean and check axle on large wheel

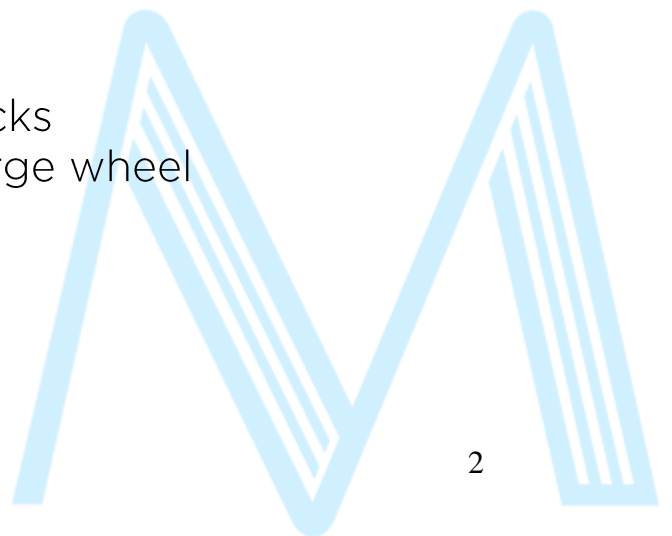

Wheel locks – If the wheel locks are not holding the tire, first check to see if the tire is properly inflated. If this is not an issue, next check the bolts for any excessive play. If there is side to side play, tighten each bolt that is loose until there is only minimal play. Do not over tighten, for this will make the wheel locks very difficult to engage. If this does not solve the problem, next loosen the two bolts on the wheel lock clamp that connects the wheel lock to the frame. Once loose, the wheel lock assembly should be moved to the proper position and the bolts retightened. As you tighten, alternate between the bolts, so the clamp is symmetrically tightened. If any part of the mechanism is bent or the bolts/nuts do not tighten, then the wheel lock needs to be replaced.

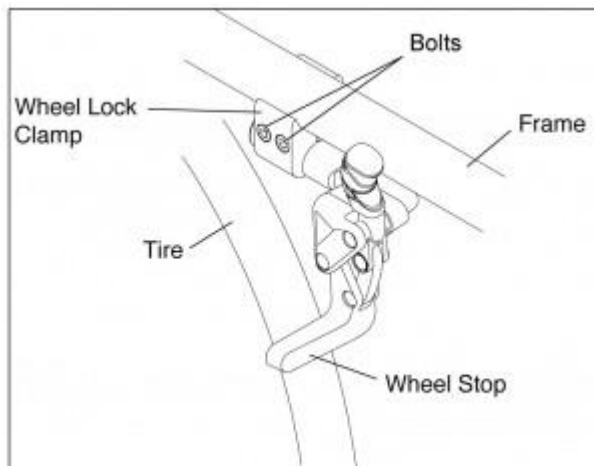

Be sure to use the proper size hex wrench. If the wrench fits, but not exactly, you may need a metric hex wrench or vice versa. Be sure to use a proper fitting wrench, otherwise there is a high probability that you will strip the bolt. Once stripped, the bolt will need to be drilled out in order to remove it. This often requires the expertise of a profession wheelchair repair technician.

Wheel Spokes - Checking the tension of the spokes on your wheelchair is important as one loose spoke will cause the others to carry more tension and ultimately the wheel will go out of round. To check the tension of your spokes you can do the sound test, feel test or better yet – both:

- Testing by sound: Run a pencil against each spoke while the wheel is spinning. You should hear a nice “pinging” sound.
- Testing by feel: Squeeze two adjacent spokes toward each other and compare the tightness. All spokes should be equally tight. If any spokes vibrate, sound dull or do not feel equally tight then they should be tightened using your spoke wrench.

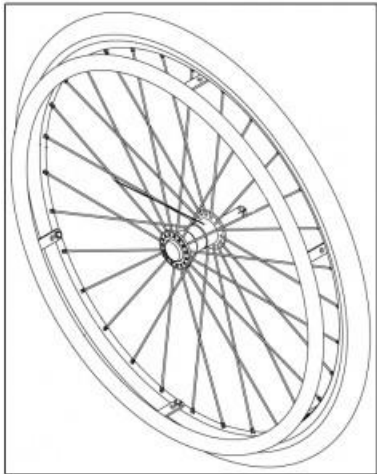

Pneumatic tires – At least weekly, if not more often, check the pressure in your tires. The proper tire pressure should be indicated directly on the tire. Proper inflation of your tires can make a big difference in how your chair performs. Low tire pressure increases rolling resistance, which increases stress on your shoulders and upper extremities, and thereby places you at higher risk for injury. Increased rolling resistance also makes you work harder and fatigue quickly.

Replacing a Flat Tire

1. Deflate the tire as much as possible.
2. Insert a tire lever under one edge of the tire above a spoke, push down on the lever until that area of the tire flips off the rim. Secure the “hooked” end of the tire lever around the corresponding spoke.
3. Insert the second tire lever a few inches from the first lever. Again, push down on the lever until

that area of the tire flips over the rim. Then slide this tire lever around the tire in a clockwise direction until one edge of the tire is completely removed from the rim.

4. Remove the tube.
5. Run your finger along both the inside of the tire and along the rim and remove any pieces of glass or any other sharp objects or surfaces which may have damaged the tube.
6. Inflate the new tube until it holds its circular shape.
7. Place the tube in the tire such that the valve stem inserts through the appropriate hole in the rim.
8. Knead (by hand) the tire back onto the rim starting at the valve stem and moving along the rim. You may not be able to get the tire completely back on the rim using only your hands. The tire levers can be used to secure the rest of the tire on the rim.
9. Re-inflate the tube to the pressure recommended on the tire.

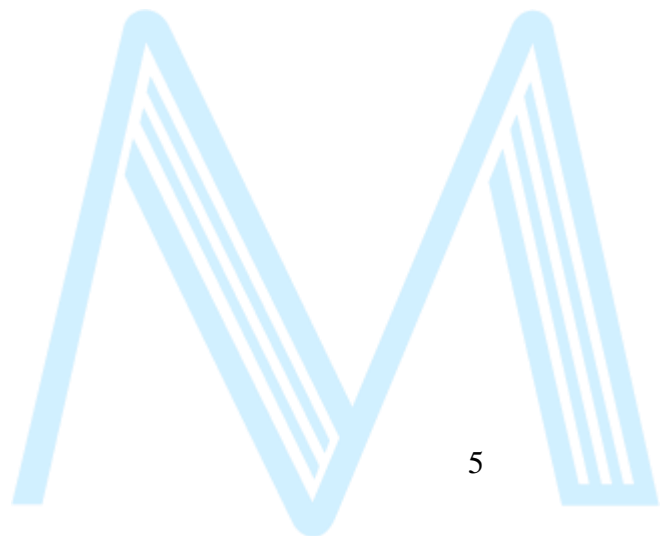

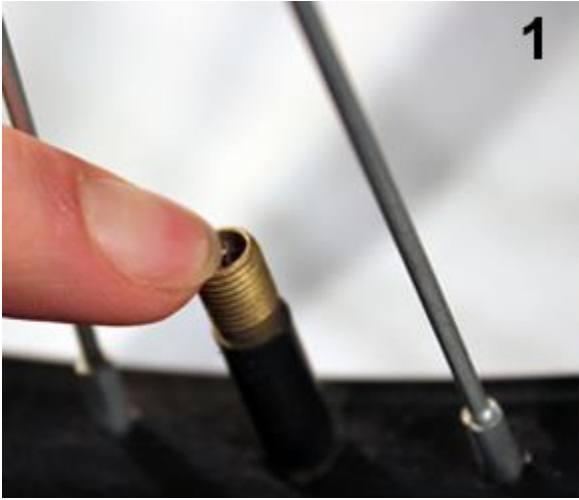

Replacing a Tire - Tires can either be purchased from your wheelchair vendor or bike shop. Some tires available from the bike shops are black and contain carbon, which can mark up floors and wear out carpet more quickly. However, the back tires will normally last longer and are less expensive to purchase. Bike shops have also now started to carry some more common sizes of carbon free wheelchair tires (gray in color). Alternatively, the bike shop can order either the carbon containing or carbon free tires for you at a fraction of the cost of purchasing them through the wheelchair vendor

Wipe down chair - Wipe down the chair with a clean, damp rag. Any cleaner that is recommended for bicycle frames is appropriate for wheelchairs. Avoid cleaners that contain bleach, it may damage the paint. It is best to avoid spraying anything directly on the chair. It is better to spray cleaner on a rag and then wipe down your chair. **Even if your chair gets really dirty resist the temptation to spray it down with a hose or power washer as high pressure water can force the grease out of the sealed bearings and cause them to rust.** You can use an old toothbrush to remove the dirt from more difficult to clean areas.

Casters - Clean any debris accumulated in the front casters and check casters for proper stability and play. Remove the caster wheel from the fork and clean out any hair and other debris that have built up.

The caster needs to be replaced if:

The caster tire is worn.

The caster wobbles as it is spun.

The caster does not spin freely when free of any resistance such as the floor or hair around the axle.

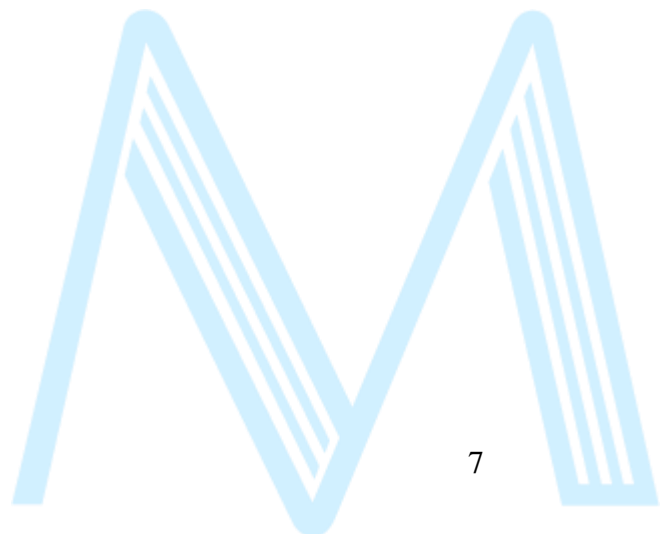
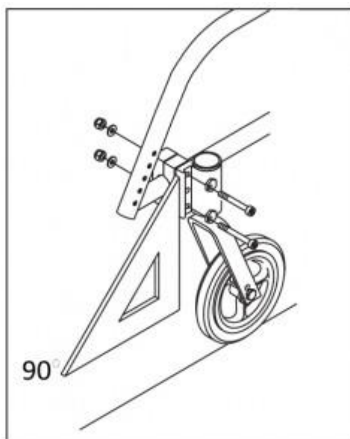

Tracking – Tracking is defined as the path the wheelchair takes when coasting. When the chair pulls to the side it is often due to the casters being out of alignment. The vertical alignment may be off, the caster fork may be bent, or there may be more hair wrapped around one axle as compared to the other. Asymmetrical tire pressure, setting of Camber or Center of Gravity adjustment of the rear wheels may also affect the tracking. A bent frame may also cause poor tracking. Unless you take the time to become really familiar with these settings you will be best off to take the chair into the shop for repair of a tracking problem.

Back canes – Check bolts on adjustable height back canes and tighten as needed. Check bolts on the angle adjustable mechanism and tighten as needed.

Backrests – Rigid Backs – Check to ensure brackets are properly positioned and secure. Most of the rigid backrests utilize brackets to secure the backrests to the wheelchair. Make sure that the bolts to secure the backrests are tight. Also, check to see that the brackets are level when comparing from one side to other. Sometimes, the brackets can loosen and slide up or down on the frame of the chair resulting in one side of the backrest being higher or lower than the other side. This can throw your posture off and cause decreased balance and/or pain.

Adjustable Sling Back – check the tension of the backrest and tighten up the areas that may have stretched out over time. There are usually Velcro straps which can be used to tighten specific areas of the backrest. Pay particular attention to the low back area of the backrest that should be kept tight enough to adequately support the curve in your low back. As the back stretches out it no longer holds your back in a proper sitting position and can throw you balance off and/or cause pain, or even skin problems.

Sling seats – check the tension of the sling seat. If the middle of the front edge of the seat sling is lower than the seat rails by ½” or more, it is time to be replaced. A slung seat compromises the support needed to provide adequate

positioning, especially with ROHO cushions. This can throw the alignment of your pelvis, hips, spine and legs off and cause you pain or skin problems.

Loose Nuts and Bolts – Tighten any bolts that are loose. Most screws can be tightened up until they are securely tightened. If a bolt or nut is getting severely stripped and it is becoming more difficult to tighten, then it should be replaced. Most nuts and bolts can be purchased at the local hardware store. Be sure to replace the bolt or nut with the exact same type. Some after market backs may have metric bolts and nuts. Some chairs have all metric bolts and nuts. Do not replace a partly solid/partly threaded bolt (called a lag bolt) with an all-threaded bolt (screw). Do not substitute damaged nuts and bolts with those of alternative grades and configurations. There is a number label on the head of the bolt that signifies the strength; the higher the number the stronger the bolt. Only replace bolts with those of the same strength grading.

Center of gravity adjustment – This adjustment of the rear wheel axle(s) determines how tippy the wheelchair is. The further rearward the center of gravity is the less tippy the chair is. This adjustment is often made with input from your therapist. If you feel that your wheelchair is too tippy or you have difficulty getting the front casters up and over thresholds then you should contact your therapist for adjustment.

Cushion – Check the cushion for bottoming out.

ROHO or other air cushions: At least weekly, check to ensure that your ROHO is properly inflated. Place your hand between the deepest bony prominence (normally butt bones or tailbone) and the cushion. There should be $\frac{1}{2}$ " or one finger width of air between the deepest bony prominence and the bottom of the cushion. If you are bottoming out the ROHO will need to be re-inflated. If there is more than $\frac{1}{2}$ " of air then open the valve and let air out until there is $\frac{1}{2}$ " of air between

your lowest boney prominence and the bottom of the cushion.

Jay cushions – check the fluid pad for low spots and foam base for areas of compression.

Varilite cushion - To sink into the cushion open the valve, twist to the left, counter clockwise, for a short time then close the valve quickly, twist to the right or clockwise. Check proper depth the same way as the ROHO. To re-inflate the cushion, open the valve when not sitting on it. To maintain the cushion open the valve overnight once a week. Remember to close the valve before sitting on the cushion. To adjust the inflation of the cushion, open the valve for a brief period until it is at desired level.

Clean cushion and cover

ROHO

Cover can be machined washed in cold water and air-dried. To clean the cushion, deflate the cushion, close valves and place in large sink. Use a sponge or washcloth to gently scrub air cells and spaces between. ROHO suggests using a liquid dishwashing or laundry detergent or other general-purpose cleaning liquid.

Jay

To clean the cover: Remove the cover from the foam base and turn inside out. Machine wash in warm water and drip or tumble dry on low heat. Do not dry clean or use industrial washers and dryers to clean cover. Do not bleach.

To clean foam base and positioning components, remove the cover, fluid pad, and PLA reducer ring (if applicable) from the foam base. Wipe lightly with a damp cloth. Do not use soap. Do not submerge in water. Wipe off with a clean cloth. Let it completely air-dry before reassembly. Avoid submersion of the foam base in water.

To clean fluid pad and fluid inserts, wipe with warm water and soap. Rinse with a clean, damp cloth. Then wipe dry with a clean cloth.

Never submerge the fluid pad in any liquid. Avoid harsh cleaning or rough handling as this may lead to a degradation of the fluid insert.

From Sunrise Medical

Varilite

To clean cover remove and machine wash per tag and air dry.

To clean cushion, wipe down with a damp cloth.

To clean base or wedges use soap and water. Do not saturate.

Air dry.

Repair

ROHO cushion - Every ROHO cushion comes with a patch.

1. Place your cushion cells down and over-inflate.
2. Immerse the over-inflated cushion in water to locate the leak. (look for the air bubbles.)
3. Once the leak has been located, mark the leak by inserting a toothpick into the hole.
4. Allow the cushion to dry thoroughly.
5. Clean the area around the hole with the alcohol wipe provided. Let surface dry.
6. Peel backing from patch provided, center the patch and place it over the hole.
7. Press the patch down firmly until a good seal is achieved.
8. Adjust the cushion to proper inflation.

Varilite cushion - There are patches available from the manufacturer.



Eduardo Jimenez, E.C.E. (Engg)
Solutions Expert
Lead Technician & Service Coordinator
Macdonald's Home Health Care

148 W. 6th Avenue, Vancouver BC
www.macdonaldshhc.com

Your Partner in Comfort and Mobility